

Endomed S.r.l.s.

via Appia lato Napol, 220
04023 Formia (LT)(Italia)

Part.Iva. 02922120593

Mail: info@endomed srl.com

www.endomed srl.com

Tel. : 0823 1656213

Fax : 0823 932337



Technische Änderungen vorbehalten
We reserve the right to make alterations
Sous réserve de modifications techniques
Cambios técnicos reservados
Ci riserviamo il diritto di modifiche tecniche



OTOLOGIE

OTOLOGY

OTOLOGIE

OTOLOGÍA

OTOLOGIA



MEDICI

Ohrspekula (Ohrtrichter)
 Ear Specula
 Spéculums auriculaires
 Espéculos auriculares
 Specoli auricolari

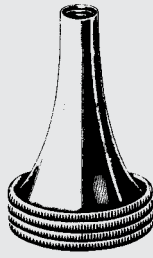

HARTMANN
 144-0100-00
 Set=4
 4,5 - 7,5 mm

ø mm	3,0	144-0100-30	144-0101-30
ø mm	4,5	144-0100-45	144-0101-45
ø mm	5,5	144-0100-55	144-0101-55
ø mm	6,5	144-0100-65	144-0101-65
ø mm	7,5	144-0100-75	144-0101-75

schwarz
 black
 noirs
 negros
 neri

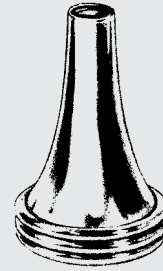

TOYNBEE
 144-0102-00
 Set=3
 5,5 - 7,5 mm

ø mm	5,5	144-0102-55
ø mm	6,5	144-0102-65
ø mm	7,5	144-0102-75

OTOLOGIE

OTOLOGY

OTOLOGIE

OTOLOGÍA

OTOLOGIA



GRUBER
 144-0104-00
 Set=4
 4,5 - 7,5 mm

ø mm	4,5	144-0104-45
ø mm	5,5	144-0104-55
ø mm	6,5	144-0104-65
ø mm	7,5	144-0104-75

rund - round - rondes
 redondos - rotondi



GRUBER
 144-0105-00
 Set=3
 5,5 - 7,5 mm

ø mm	4,5	144-0105-45
ø mm	5,5	144-0105-55
ø mm	6,5	144-0105-65
ø mm	7,5	144-0105-75

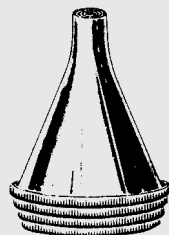

BOUCHERON
 144-0108-00
 Set=4
 5,0 - 8,0 mm

ø mm	5,0	144-0108-50
ø mm	6,0	144-0108-60
ø mm	7,0	144-0108-70
ø mm	8,0	144-0108-80



FARRIOR
 144-0200-01 - 144-0200-09
 144-0200-00 Set=9
 3,3 - 7,7 mm

ø mm	3,3	144-0200-01
ø mm	4,3	144-0200-02
ø mm	4,8	144-0200-03
ø mm	5,3	144-0200-04
ø mm	5,8	144-0200-05
ø mm	6,3	144-0200-06
ø mm	6,7	144-0200-07
ø mm	7,2	144-0200-08
ø mm	7,7	144-0200-09

Ohrspekula für die pneumatische Prüfung
 Ear Specula for Pneumatic Test
 Spéculums auriculaires pour le test pneumatique
 Espéculos auriculares para el test neumático
 Specoli auricolari per il test pneumatico

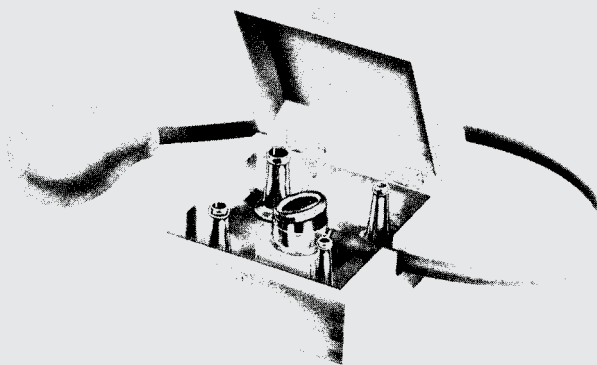

BRUENINGS compl.
 144-0300-04

Mit Lupe, 4 Ohrspekula
 mit Gebläse, in Holzetui

With Magnifying Lens,
 4 Ear Specula, Rubber Ball,
 in Wooden Box

Avec loupe grossissante,
 4 spéculums auriculaires,
 poire soufflante, en boîte bois

Con lente de aumentar,
 4 espéculos auriculares,
 soplera, en estuche de madera

Con lente d'ingrandimento,
 4 specoli auricolari, con
 soffiera, in scatola di legno

OTOLOGIE

OTOLOGY

OTOLOGIE

OTOLOGÍA

OTOLOGIA

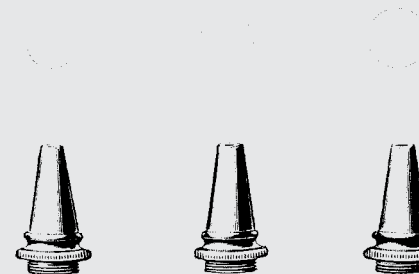

Mit 3 Spekula und Gebläse
 With 3 Specula and Rubber Tube with Bulb
 Avec 3 spéculums en métal, poire soufflante et tube
 Con 3 espéculos, insuflador y tubo
 Con 3 specoli, palla soffiatrice e tubo

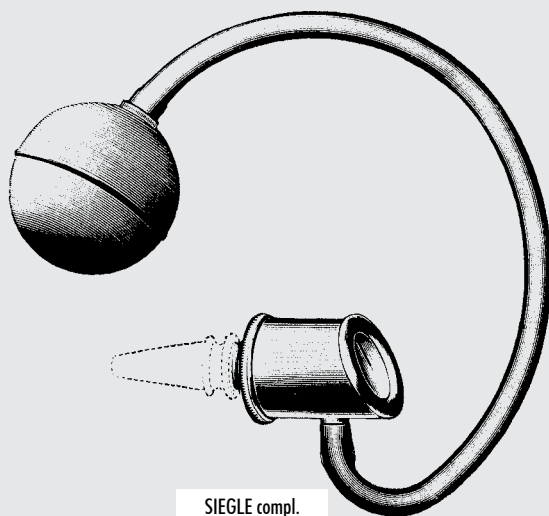

SIEGLE compl.
 144-0306-03



Stimmgabeln
Tuning Forks
Diapasons
Diapasones
Diapason

OTOLOGIE

OTOLOGY

OTOLOGIE

OTOLOGÍA

OTOLOGIA

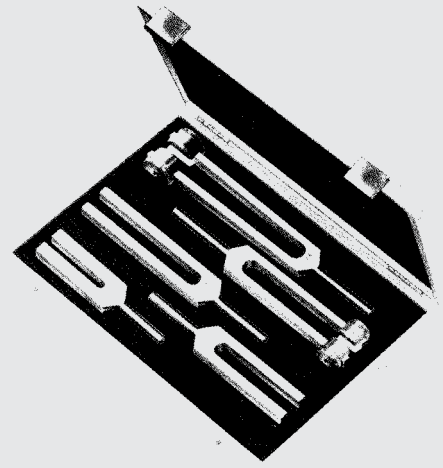
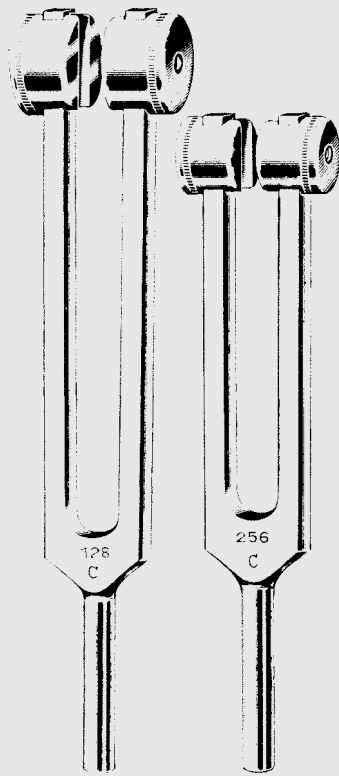

ALU compl.
144-0601-00

ALU				
144-0600-01	144-0600-02	144-0600-03	144-0600-04	144-0600-05
C 128	C 256	C ² 512	C ³ 1024	C ⁴ 2048

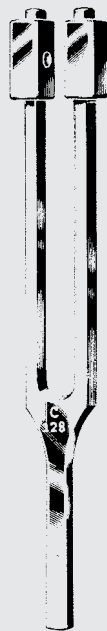

HARTMANN compl.
144-0701-00

HARTMANN				
144-0700-01	144-0700-02	144-0700-03	144-0700-04	144-0700-05
C 128	C 256	C ² 512	C ³ 1024	C ⁴ 2048



144-0600-01



LUCAE
144-0704-01
C 128

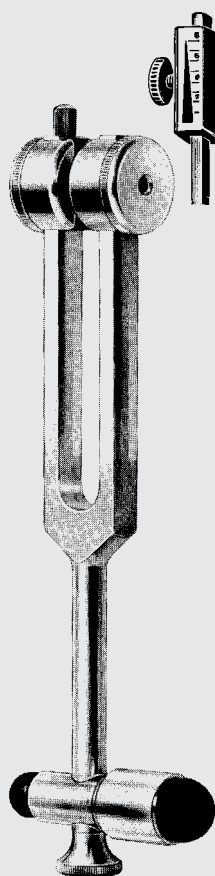

144-0705-00
neurolog.

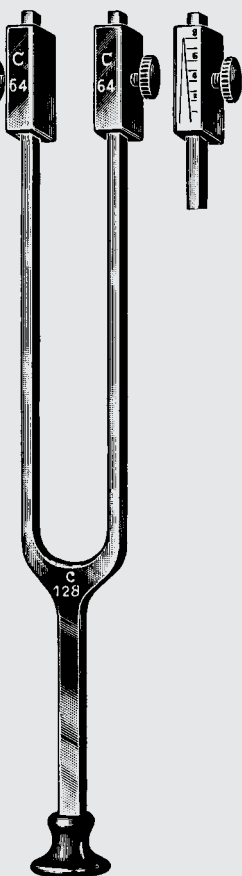

RYDEL-SEIFFER
144-0706-01
C 64 / C 128



144-0708-00
A 440

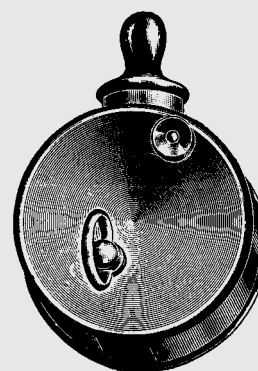

Auch für Neurologie
Also for Neurology
Aussi pour névrologie
También para neurología
Anche per neurologia

BARANY
144-0800-00

Stimmgabeln, Lärmapparat
Tuning Forks, Noise Apparatus
Diapasons, Assourdisseur
Diapasones, Ensordecedor
Diapason, Assordatore

OTOLOGIE

OTOLOGY

OTOLOGIE

OTOLOGÍA

OTOLOGIA

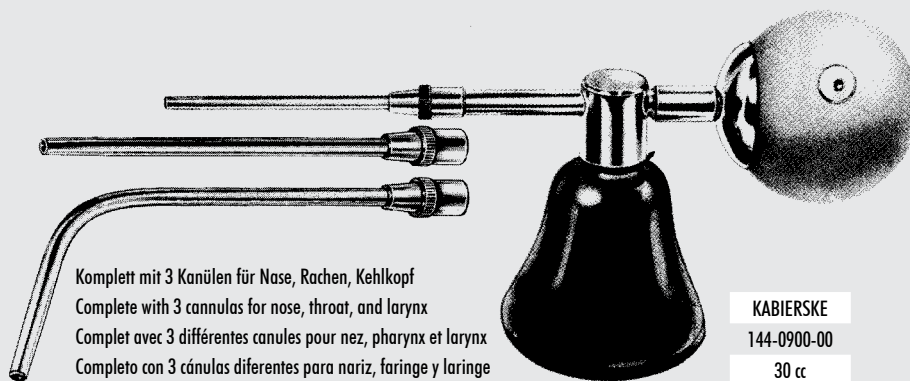

Komplett mit 3 Kanülen für Nase, Rachen, Kehlkopf
Complete with 3 cannulas for nose, throat, and larynx
Complet avec 3 différentes canules pour nez, pharynx et larynx
Completo con 3 cánulas diferentes para nariz, faringe y laringe
Completo di 3 cannule diversi per naso, faringe e laringe

KABIERSKE
144-0900-00
30 cc

Komplett mit 3 Kanülen für Nase, Rachen, Kehlkopf,
mit Metallfuß
Complete with 3 cannulas for nose, throat, and larynx,
with Metal Base
Complet avec 3 différentes canules pour nez, pharynx et
larynx, avec socle en métal
Completo con 3 cánulas diferentes para nariz, faringe y
laringe, con soporte de metal
Completo di 3 cannule diversi per naso, faringe e laringe,
con placca di metallo

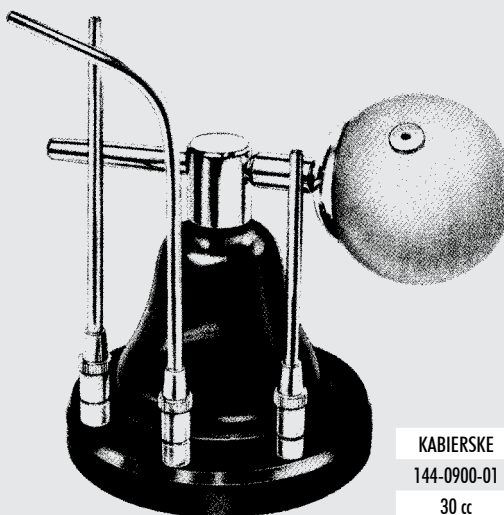

KABIERSKE
144-0900-01
30 cc

Pulverbläser
Powder Blowers
Lance-Poudre
Lanzapolvo
Insoffiatori per polvere

Luftdusche
Air Bag
Insufflateur d'air
Insuflador de aire
Insoffiatore d'aria

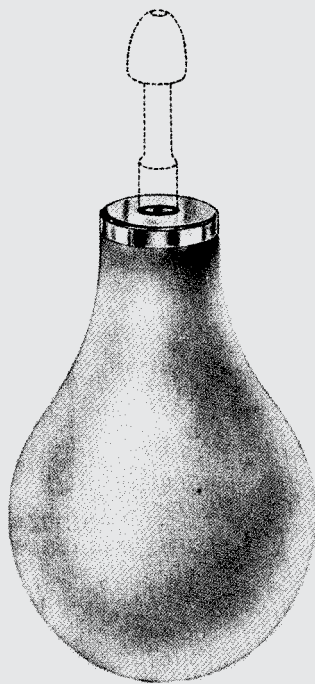

144-0901-03

144-0901-04
ø 4 mm144-0901-15
ø 15 mm144-0901-17
ø 17 mm144-0901-22
ø 22 mm

144-0901-35

OTOLOGIE

POLITZER

144-0901-00 = incl. 144-0901-15, 144-0901-17, 144-0901-22, 144-0901-03

144-0901-01 = incl. 144-0901-15, 144-0901-17, 144-0901-22, 144-0901-03, 144-0901-04

OTOLOGY

OTOLOGIE

OTOLOGÍA

OTOLOGIA

Ohrspritzen, Saugrohre
Ear Syringes, Aspirating Tubes
Seringues auriculaires, Tubes d'aspiration
Jeringas para oídos, Tubos de aspiración
Siringhe auricolari, Tubi da aspirazione

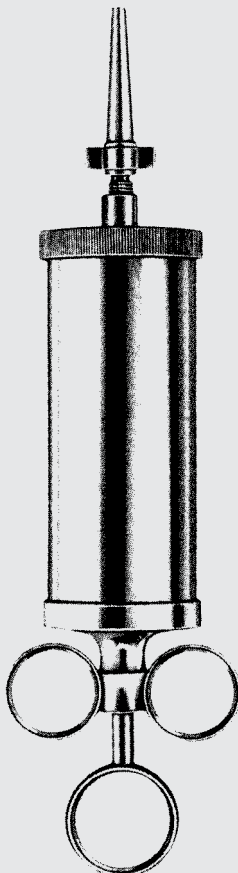

ml	REINER
50	144-0906-50
75	144-0906-75
100	144-0907-10
150	144-0907-15

Ganzmetall, komplett, mit 2 Aufsätzen und 1 Schutzeller
All Metal, complete, with 2 Tips and 1 Protective Shield
Entièrement en métal, complet avec 2 embouts et plaque protectrice
Completamente de metal, con 2 cánulas y placa protectora
Completamente in metallo, con 2 punte e placca protettiva

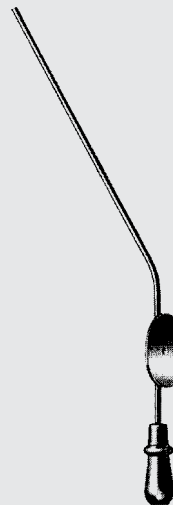

ø mm	BARON (SCHUKNECHT)
1,0	144-1001-03
1,5	144-1001-05
2,0	144-1001-06

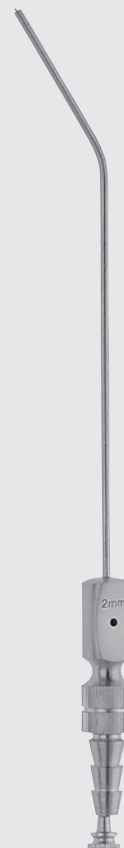

ø mm	PLESTER
1,5	144-1003-15
2,0	144-1003-20
2,5	144-1003-25
3,0	144-1003-30

19,5 cm

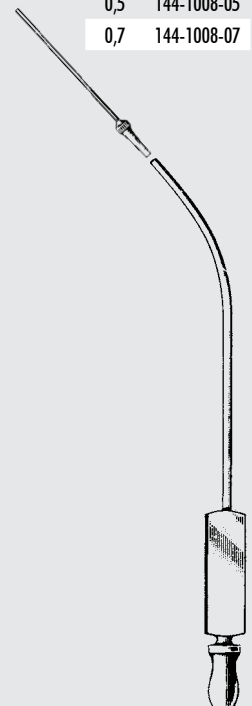

ø mm	
0,5	144-1008-05
0,7	144-1008-07

cm	ZOELLNER
15,0	144-1007-15

Ohrküretten
Ear Curettes
Curettes auriculaires
Curetas auriculares
Curette auricolari

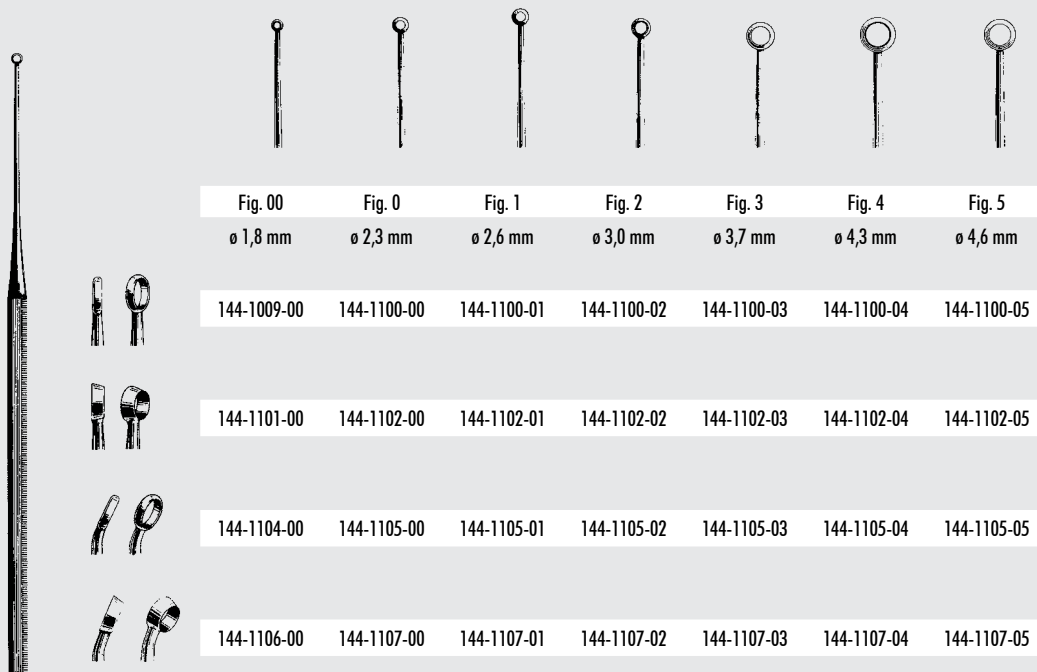

Fig. 00	Fig. 0	Fig. 1	Fig. 2	Fig. 3	Fig. 4	Fig. 5
ø 1,8 mm	ø 2,3 mm	ø 2,6 mm	ø 3,0 mm	ø 3,7 mm	ø 4,3 mm	ø 4,6 mm
144-1009-00	144-1100-00	144-1100-01	144-1100-02	144-1100-03	144-1100-04	144-1100-05
144-1101-00	144-1102-00	144-1102-01	144-1102-02	144-1102-03	144-1102-04	144-1102-05
144-1104-00	144-1105-00	144-1105-01	144-1105-02	144-1105-03	144-1105-04	144-1105-05
144-1106-00	144-1107-00	144-1107-01	144-1107-02	144-1107-03	144-1107-04	144-1107-05

BUCK
144-1009-00 - 144-1107-05

144-1009-00 - 144-1100-05 gerade, stumpf / straight, blunt / droites, mousses / rectas, romas / rette, smusse
 144-1101-00 - 144-1102-05 gerade, scharf / straight, sharp / droites, tranchantes / rectas, cortantes / rette, taglienti
 144-1104-00 - 144-1105-05 abgewinkelt, stumpf / angled, blunt / coudées, mousses / acodadas, romas / angolate, smusse
 144-1106-00 - 144-1107-05 abgewinkelt, scharf / angled, sharp / coudées, tranchantes / acodadas, cortantes / angolate, taglienti

OTOLOGIE

OTOLOGY

OTOLOGIE

OTOLOGÍA

OTOLOGIA

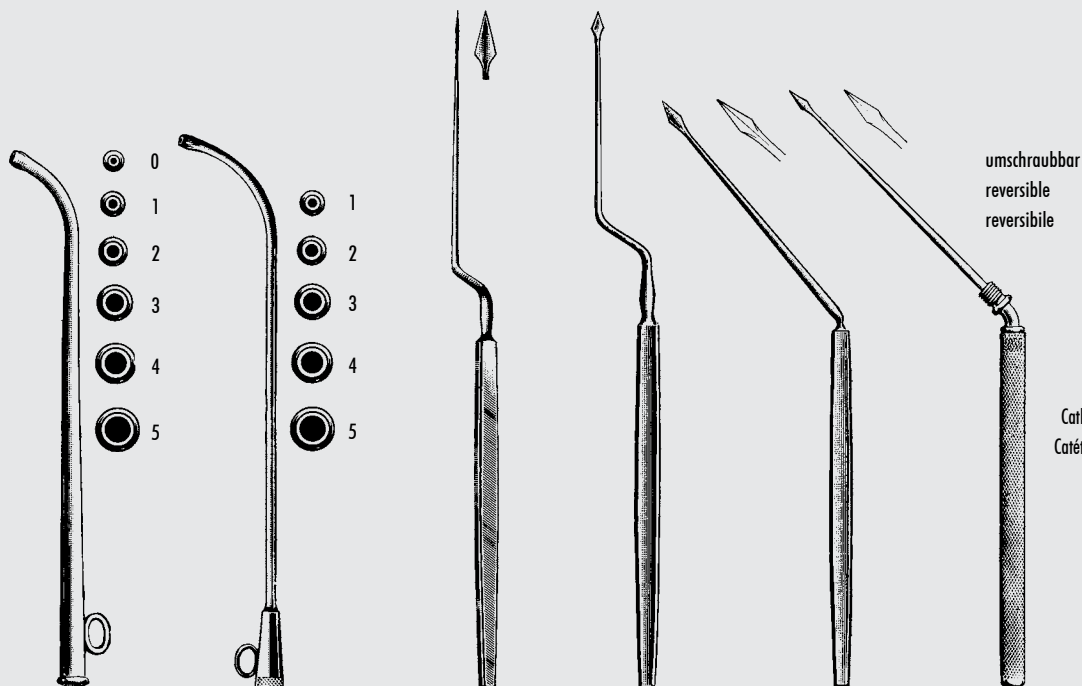

umschraubbar
reversible
reversible

Ohrkatheter, Paracentesenadeln
Ear Catheters, Paracentesis Needles
Cathéters auriculaires, Aiguilles à paracentèse
Catéteres auriculares, Aguja para paracentesis
Cateteri auricolari, Aghi per paracentesi

Fig.	HARTMANN	ITARD	cm	LUCAE	cm	POLITZER	cm	POLITZER	POLITZER
0	144-1301-00		18,0	144-1498-18	18,0	144-1500-18	16,5	144-1501-16	144-1503-16
1	144-1301-01	144-1303-01							
2	144-1301-02	144-1303-02							
3	144-1301-03	144-1303-03							
4	144-1301-04	144-1303-04							
5	144-1301-05	144-1303-05							



144-1503-16

Ohrmesser
Ear Knives
Couteaux auriculaires
Cuchillos auriculares
Coltelli auricolari

OTOLOGIE

OTOLOGY

OTOLOGIE

OTOLOGÍA

OTOLOGIA

Ohrläffel, Ohrschlingen
Ear Spoons, Ear Loops
Cuillers, Anses auriculaires
Cucharas, Asas auriculares
Cucchiai, Anse auricolari

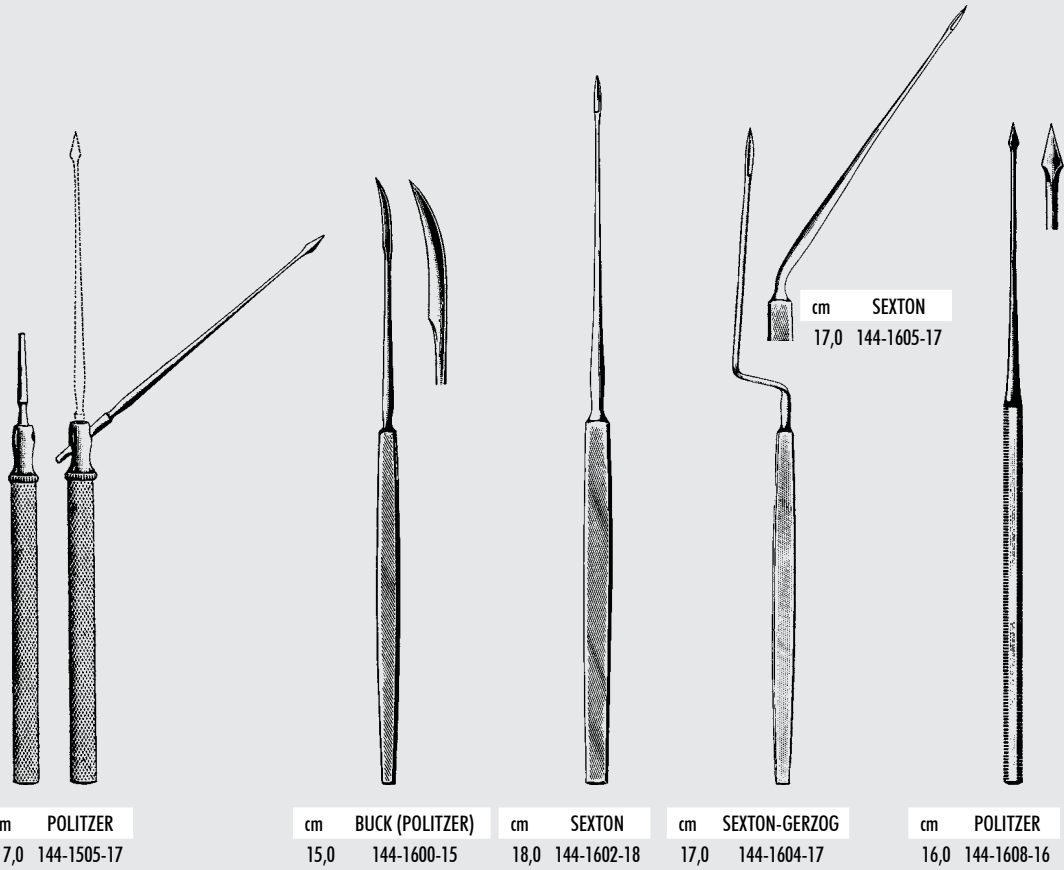

cm POLITZER
17,0 144-1505-17

cm BUCK (POLITZER)
15,0 144-1600-15

cm SEXTON
18,0 144-1602-18

cm SEXTON-GERZOG
17,0 144-1604-17

cm SEXTON
17,0 144-1605-17

cm POLITZER
16,0 144-1608-16



cm GROSS
12,0 144-1700-12



cm GROSS
12,0 144-1701-12



BILLEAU
144-1800-01 - 144-1800-03



144-1800-01



144-1800-02



144-1800-03



cm LANGENBECK
13,0 144-1802-13

scharf / stumpf
sharp / blunt
tranchant / mousse
cortante / romo
tagliente / smusso

stumpf / stumpf
blunt / blunt
mousse / mousse
romo / romo
smusso / smusso



144-1900-01

144-1900-02

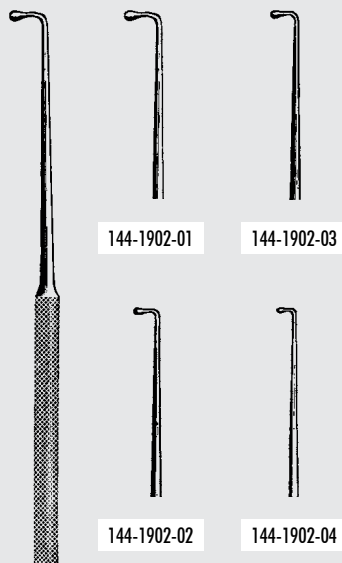

144-1902-01

144-1902-03

144-1902-02

144-1902-04

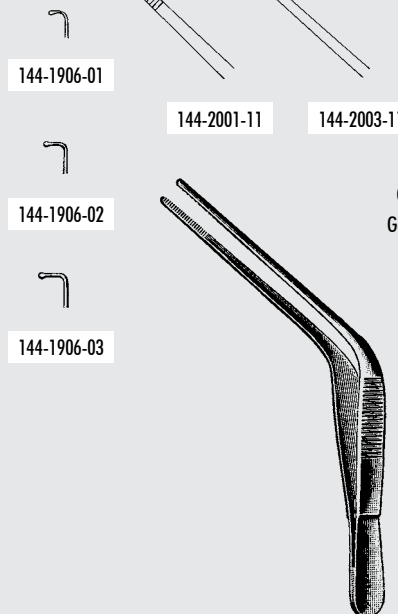

144-1906-01

144-1906-02

144-1906-03

144-2001-11

144-2003-11

1:2

DAY
144-1900-01 - 144-1900-02

WAGENER
144-1902-01 - 144-1902-04

cm LUCAE
14,0 144-1906-01 - 144-1906-03

cm WILDE (TROELTSCH)
12,0 144-2001-11 - 144-2003-11

Ohrhäkchen, Ohrpinzetten
Ear Hooklets, Ear Forceps
Crochets auriculaires, Pinces auriculaies
Ganchitos auriculares, Pinzas auriculares
Uncinetti auricolari, Pinze auricolari

OTOLOGIE

OTOLOGY

OTOLOGIE

OTOLOGÍA

OTOLOGIA

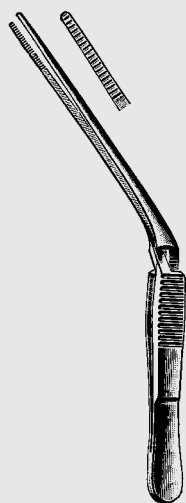

cm TROELTSCH (WILDE)
13,0 144-2005-13



cm LUCAE
14,0 144-2006-14



cm JANSEN
16,0 144-2006-16
20,0 144-2006-20

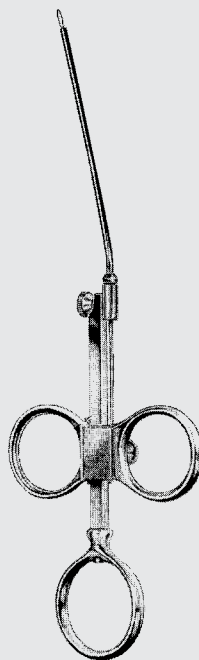

cm KRAUSE
16,0 144-2200-16

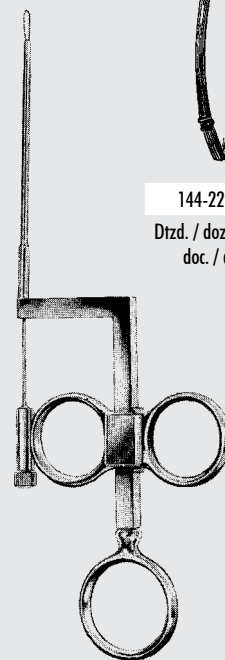

cm WILDE
17,0 144-2202-17

144-2205-02

Dtzd. / doz. / douz /
doc. / dozz.

Ohrpinzetten, Ohrpolypenschnürer
Ear Forceps, Ear Polypus Snares
Pinces auriculaires, Serre-nœud à polypes auriculaires
Pinzas auriculares, Cierranudos para pólipos auriculares
Pinze auricolari, Serranodi per polipi auricolari



144-2205-02

44.11

Ohrzängchen
Ear Forceps
Pincés auriculaires
Pinzas auriculares
Pinze auricolari

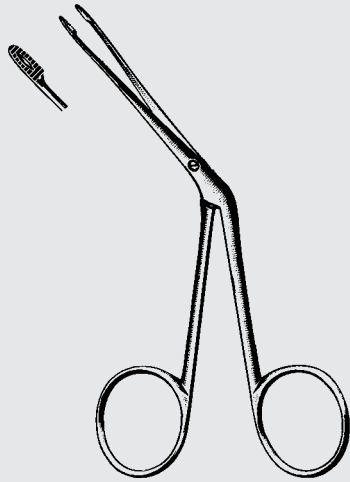

cm HARTMANN
12,0 144-2401-12

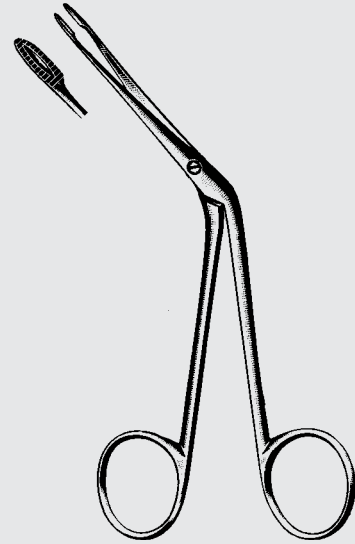

cm HARTMANN
14,0 144-2401-14

OTOLOGIE

OTOLOGY

OTOLOGIE

OTOLOGÍA

OTOLOGIA

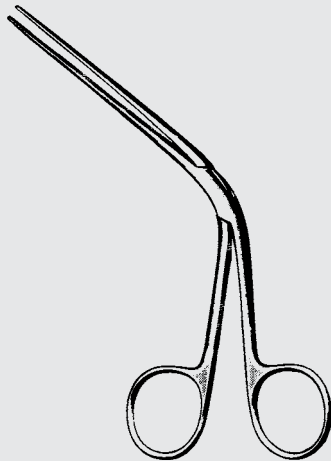

cm TILLEY
14,0 144-2403-14



cm LITTAUER
12,0 144-2405-12

Fremdkörperheber
Foreign Body Levers
Leviers pour corps étrangers
Elevadores para cuerpos extranjerros
Leve per corpi estranei

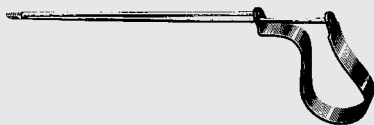

cm QUIRE
10,0 144-2501-10

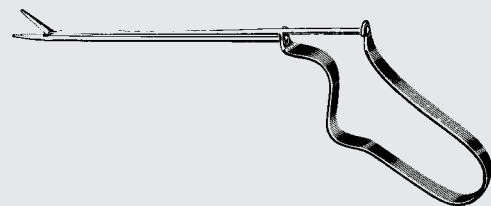

cm BUCK
11,0 144-2503-11

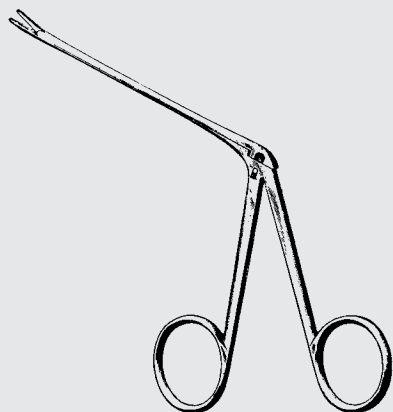

144-2505-08 - 144-2705-08



cm HARTMANN-WULLSTEIN
8,5 144-2505-08



cm HARTMANN-WULLSTEIN
8,5 144-2507-08



cm HARTMANN
8,5 144-2601-08
14,0 144-2601-14
16,0 144-2601-16



cm HARTMANN
8,5 144-2603-08
14,0 144-2603-14



cm HARTMANN
8,5 144-2605-08
14,0 144-2605-14
16,0 144-2605-16



ø mm HARTMANN 8,5 cm
1,0 144-2607-10
2,0 144-2607-20
2,5 144-2607-25
3,0 144-2607-30
3,5 144-2607-35



cm HARTMANN
8,5 144-2609-30



cm STRUEMPEL
8,5 144-2701-08
14,0 144-2701-14



mm HARTMANN 8,5 cm
1,0 144-2703-08
1,5 144-2703-09



cm HARTMANN-HOFFMANN
8,5 144-2705-08

Ohrzängchen
Ear Forceps
Pincès auriculaires
Pinzas auriculares
Pinze auricolari

OTOLOGIE

OTOLOGY

OTOLOGIE

OTOLOGÍA

OTOLOGIA

Mikro-Ohrscherchen
Micro Ear Scissors
Ciseaux auriculaires micro
Tijeras auriculares micro
Forbici auricolari micro

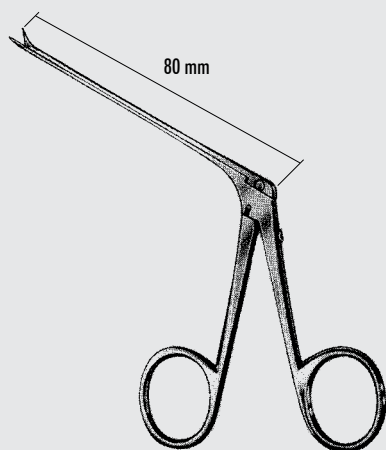

144-3100-40 - 144-3202-70



BELLUCCI
144-3100-40
micro mini
4,0 mm



BELLUCCI
144-3102-55
micro standard
5,5 mm



BELLUCCI
144-3103-55
micro standard
5,5 mm



« BELLUCCI
144-3105-55
micro standard
5,5 mm



» BELLUCCI
144-3107-55
micro standard
5,5 mm



SHEA
144-3200-70
7,0 mm



« SHEA
144-3201-70
7,0 mm



» SHEA
144-3202-70
7,0 mm

Mikro-Ohrzängchen
 Micro Ear Forceps
 Pincès auriculaires micro
 Pinzas auriculares micro
 Pinze auricolari micro

OTOLOGIE

OTOLOGY

OTOLOGIE

OTOLOGÍA

OTOLOGIA

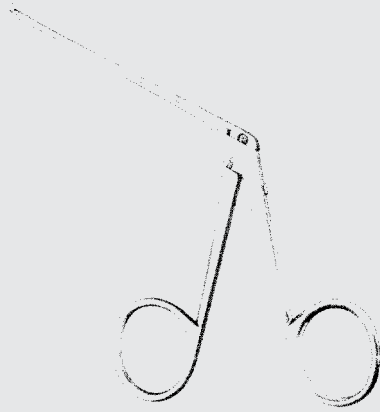

144-3500-40 - 144-3600-35

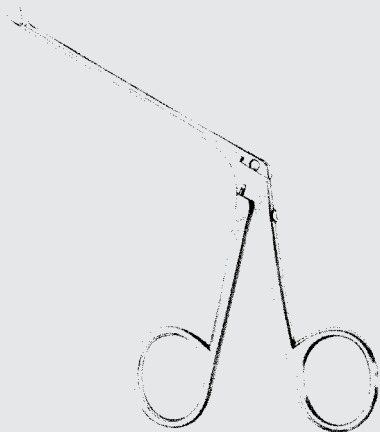

144-3602-45 - 144-3803-30



144-3500-40
4 mm



144-3500-70
7,0 mm



144-3502-40
4,0 mm



144-3503-60
6,0 mm
«



144-3505-60
6,0 mm
»



144-3507-40
4,0 mm



144-3509-40
4,0 mm



144-3600-35
3,5 mm



144-3602-45
4,5 mm



144-3603-45
4,5 mm
«



144-3605-45
4,5 mm
»



144-3607-50
5,0 mm



144-3609-50
5,0 mm



GREVEN
144-3700-50
5,0 mm



McGEE
144-3701-40
0,8 x 4,0 mm



COS
144-3703-30
1,8 x 0,8 x 3,0 mm



« JUERS
144-3705-60
6,0 mm

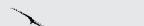

» JUERS
144-3707-60
6,0 mm



« HAUGH
144-3801-30
45° 3,0 mm

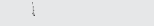

» HAUGH
144-3803-30
45° 3,0 mm

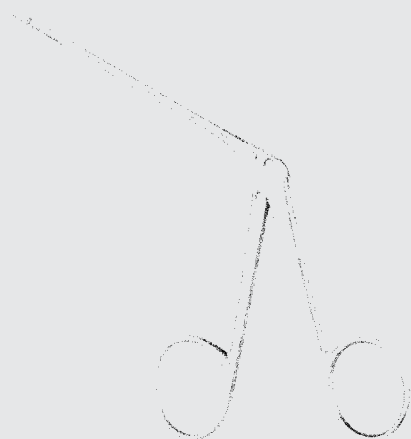

DIETER
144-3805-01 - 144-3807-02

0144380501

micro
144-3805-01

aufwärts
upward
vers le haut
hacia arriba
in alto

0144380502

micro
144-3805-02

abwärts
downward
vers le bas
hacia abajo
in basso

0144380701

mini
144-3807-01

0144380702

mini
144-3807-02

Hammerkopf-Zwickzängchen
Malleus Nippers
Pinces pour couper la tête du marteau
Pinzas para cortar la cabeza del martillo
Pinze per tagliare la testa del martello

OTOLOGIE

OTOLOGY

OTOLOGIE

OTOLOGÍA

OTOLOGIA



144-3807-02

44.15

Mikro-Ohrzängchen
 Micro Ear Forceps
 Pinces auriculaires micro
 Pinzas auriculares micro
 Pinze auricolari micro

OTOLOGIE

OTOLOGY

OTOLOGIE

OTOLOGÍA

OTOLOGIA

Modelle mit Ringgriff (RG)
 Ring Handle Style (RG)
 Modèles manches à anneaux (RG)
 Modelos mangos con anillos (RG)
 Modelli manici con anelli (RG)

144-4100-00



144-4300-00

144-4102-00



144-4302-00

144-4103-00



144-4303-00

144-4105-00



144-4305-00

144-4107-00



144-4307-00

144-4109-00



144-4309-00



144-4309-08

Modelle mit Bleistiftgriff (BG)
 Pencil Handle Style (BG)
 Modèles manches crayon (BG)
 Modelos mangos en forma de lápiz (BG)
 Modelli manici forma matita (BG)

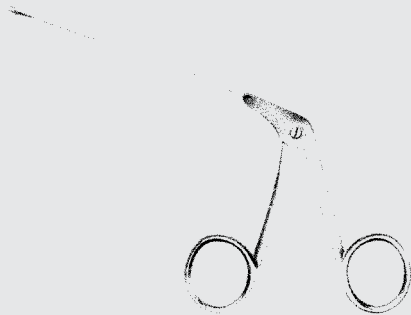

144-4100-00 - 144-4109-00

micro

RG

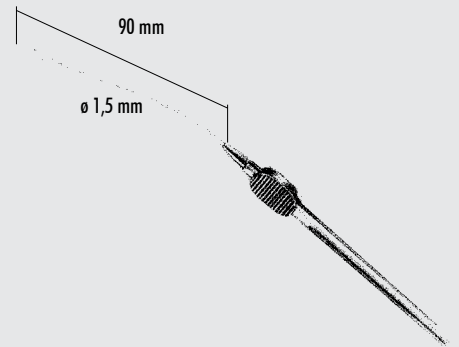

144-4300-00 - 144-4309-08

micro

BG

144-4200-00



144-4400-00

144-4202-00



144-4402-00

144-4203-00



144-4403-00

144-4205-00



144-4405-00

144-4207-00



144-4407-00

144-4209-00



144-4409-00

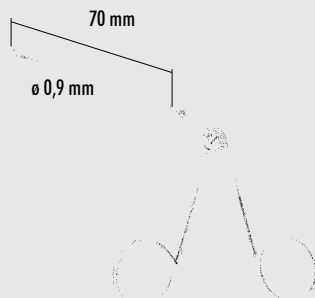

144-4200-00 - 144-4209-00

micro-mini

RG

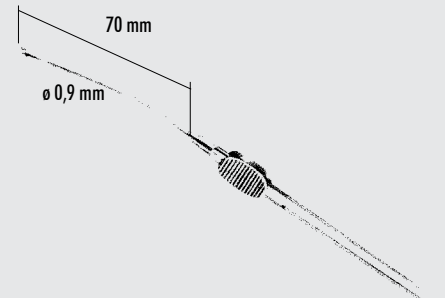

144-4400-00 - 144-4409-00

micro-mini

BG

Modelle mit Ringgriff (RG)
 Ring Handle Style (RG)
 Modèles manches à anneaux (RG)
 Modelos mangos con anillos (RG)
 Modelli manici con anelli (RG)

Modelle mit Bleistiftgriff (BG)
 Pencil Handle Style (BG)
 Modèles manches crayon (BG)
 Modelos mangos en forma de lápiz (BG)
 Modelli manici forma matita (BG)

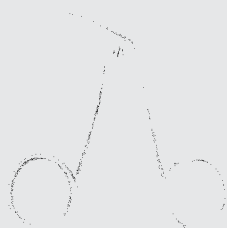

144-5100-00 - 144-5409-00
 micro
 RG



144-6100-00 - 144-6409-00
 micro
 BG

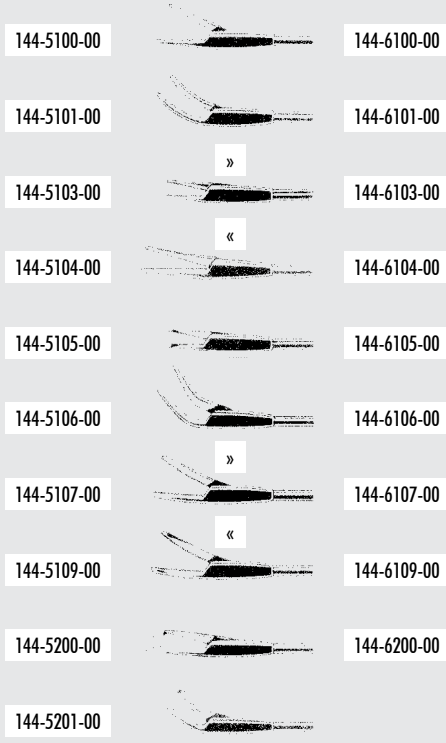

ø 1,0 mm	ø 1,5 mm	ø 2,0 mm	ø 2,5 mm
144-5202-00	144-5208-00	144-5304-00	144-5400-00
144-5203-00	144-5209-00	144-5305-00	144-5401-00
144-5205-00	144-5301-00	144-5307-00	144-5403-00
144-5207-00	144-5303-00	144-5309-00	144-5405-00

ø 1,0 mm	ø 1,5 mm	ø 2,0 mm	ø 2,5 mm
144-6202-00	144-6208-00	144-6304-00	144-6400-00
144-6203-00	144-6209-00	144-6305-00	144-6401-00
144-6205-00	144-6301-00	144-6307-00	144-6403-00
144-6207-00	144-6303-00	144-6309-00	144-6405-00

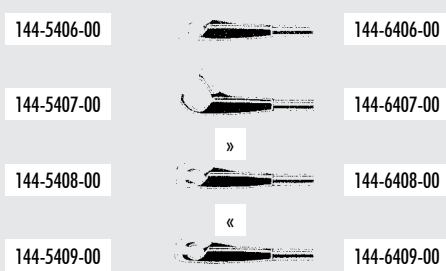

144-5406-00
144-5407-00
144-5408-00
144-5409-00

144-6406-00
144-6407-00
144-6408-00
144-6409-00

Mikro-Ohrzängchen
 Micro Ear Forceps
 Pinces auriculaires micro
 Pinzas auriculares micro
 Pinze auricolari micro

OTOLOGIE

OTOLOGY

OTOLOGIE

OTOLOGÍA

OTOLOGIA



144-6409-00



Modelle mit Ringgriff (RG)
 Ring Handle Style (RG)
 Modèles manches à anneaux (RG)
 Modelos mangos con anillos (RG)
 Modelli manici con anelli (RG)

Modelle mit Bleistiftgriff (BG)
 Pencil Handle Style (BG)
 Modèles manches crayon (BG)
 Modelos mangos en forma de lápiz (BG)
 Modelli manici forma matita (BG)

Mikro-Ohrzängchen
 Micro Ear Forceps
 Pincès auriculaires micro
 Pinzas auriculares micro
 Pinze auricolari micro

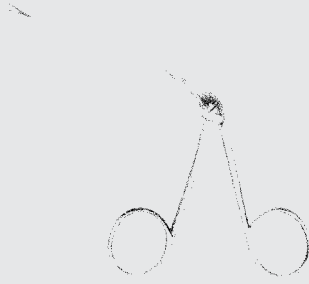

144-5500-00 - 144-5809-00
 micro-mini
 RG

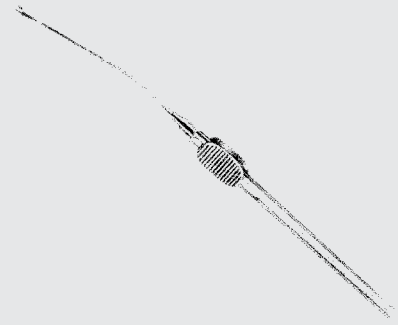

144-6500-00 - 144-6809-00
 micro-mini
 BG

OTOLOGIE

OTOLOGY

OTOLOGIE

OTOLOGÍA

OTOLOGIA

144-5500-00



144-6500-00

144-5501-00



144-6501-00

144-5503-00



144-6503-00

144-5504-00



144-6504-00

144-5505-00



144-6505-00

144-5506-00



144-5507-00



144-6507-00

144-5509-00



144-6509-00

144-5600-00



144-6600-00

144-5601-00



144-5602-00



144-6602-00

144-5603-00



144-6603-00

144-5605-00



144-6605-00

144-5607-00



144-6607-00

144-5806-00



144-6806-00

144-5807-00



144-6807-00

144-5808-00



144-6808-00

144-5809-00



144-6809-00



Instrumente für die Ohr-Mikrochirurgie
 Instruments for Ear Micro Surgery
 Instruments pour la microchirurgie de l'ouïe
 Instrumentos para la microcirugía del oído
 Strumenti per la microchirurgia auricolare



SCHUKNECHT 144-7001-01
 SCHUKNECHT 144-7001-02
 cm SCHUKNECHT 15,5 144-7003-15
 cm WULLSTEIN 15,5 144-7004-15
 cm TABB 15,5 144-7005-15
 cm PLESTER 15,5 144-7006-35
 ø 3,5 mm

OTOLOGIE

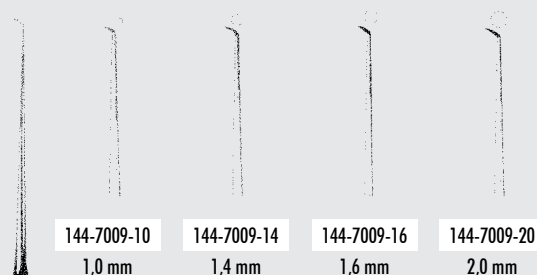

144-7009-10 1,0 mm
 144-7009-14 1,4 mm
 144-7009-16 1,6 mm
 144-7009-20 2,0 mm

OTOLOGY

OTOLOGIE

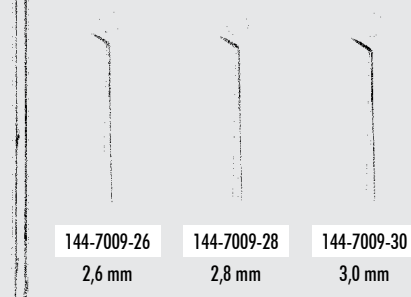

144-7009-26 2,6 mm
 144-7009-28 2,8 mm
 144-7009-30 3,0 mm

OTOLOGÍA

OTOLOGIA

ROSEN
 144-7009-10 - 144-7009-30

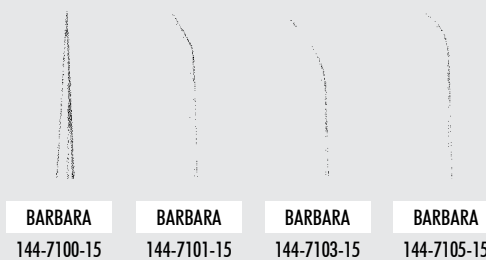

BARBARA 144-7100-15
 BARBARA 144-7101-15
 BARBARA 144-7103-15
 BARBARA 144-7105-15

	25°	45°	90°	
mm	BARBARA	BARBARA	BARBARA	BARBARA
0,3	144-7200-03	144-7202-03	144-7204-03	144-7205-05 = 0,5 mm
0,6	144-7200-06	144-7202-06	144-7204-06	144-7205-10 = 1,0 mm
0,8	144-7200-08	144-7202-08		
1,0	144-7200-10	144-7202-10	144-7204-10	
1,2		144-7202-12	144-7204-12	
1,5		144-7202-15	144-7204-15	
2,0		144-7202-20	144-7204-20	
2,5		144-7202-25	144-7204-25	

144-7100-15 - 144-7205-10



Instrumente für die Ohr-Mikrochirurgie
 Instruments for Ear Micro Surgery
 Instruments pour la microchirurgie de l'ouïe
 Instrumentos para la microcirugía del oído
 Strumenti per la microchirurgia auricolare

aufwärts
upward
en haut
hacia arriba
in alto

abwärts
downward
en bas
hacia abajo
in basso

aufwärts
upward
en haut
hacia arriba
in alto

abwärts
downward
en bas
hacia abajo
in basso



mm	90°	90°
0,3	144-7300-03	144-7302-03
0,6	144-7300-06	144-7302-06
1,0	144-7300-10	144-7302-10

mm	McGEE	McGEE
0,5	144-7303-05	144-7305-05
1,0	144-7303-10	144-7305-10

cm	BARBARA
15,5	144-7306-15

OTOLOGIE

aufwärts
upward
en haut
hacia arriba
in alto

abwärts
downward
en bas
hacia abajo
in basso

aufwärts
upward
en haut
hacia arriba
in alto

abwärts
downward
en bas
hacia abajo
in basso



cm	ROSEN
15,5	144-7307-15

mm	25°	25°	45°	45°
0,3	144-7401-03	144-7403-03	144-7405-03	144-7407-03
0,6	144-7401-06	144-7403-06	144-7405-06	144-7407-06
1,0	144-7401-10	144-7403-10	144-7405-10	144-7407-10

OTOLOGY

OTOLOGIE

OTOLOGÍA

OTOLOGIA

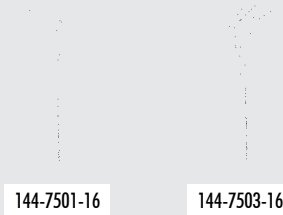

144-7501-16

144-7503-16



144-7505-16

144-7507-16

FISCH
144-7501-16 - 144-7507-16



mm
1,0 / 1,2 144-7600-01
1,5 / 1,8 144-7600-02

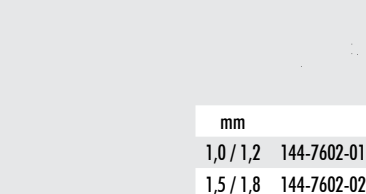

mm
1,0 / 1,2 144-7602-01
1,5 / 1,8 144-7602-02

HOUSE
144-7600-01 - 144-7602-02



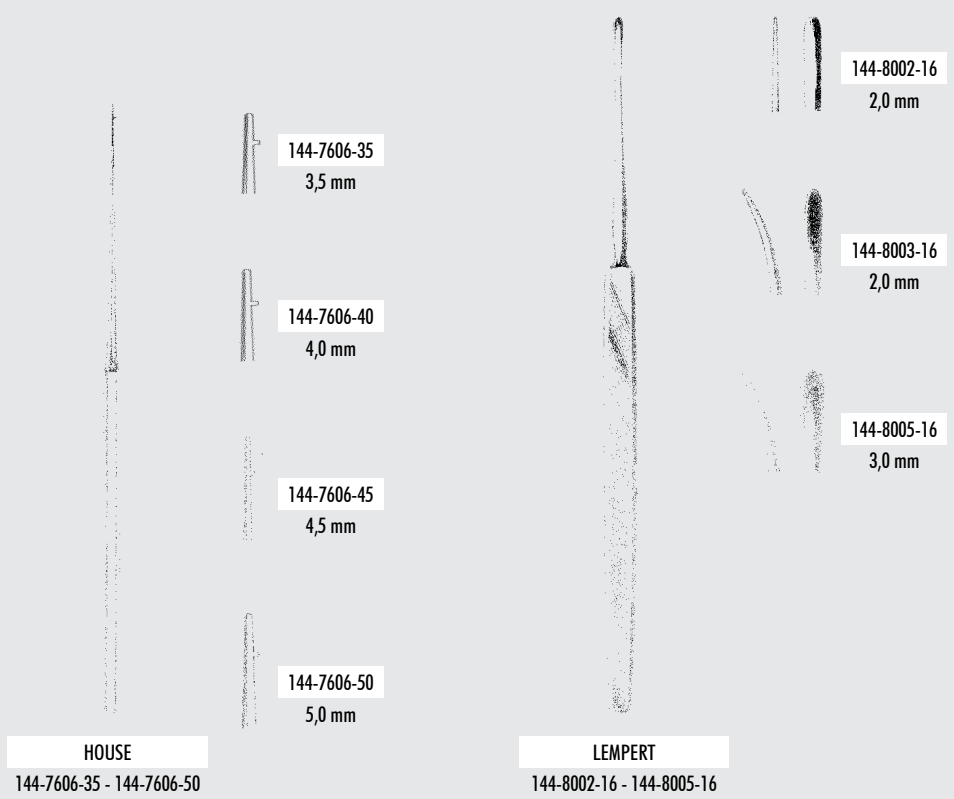

Instrumente für die Ohr-Mikrochirurgie
Instruments for Ear Micro Surgery
Instruments pour la microchirurgie de l'ouïe
Instrumentos para la microcirugía del oído
Strumenti per la microchirurgia auricolare

OTOLOGIE

OTOLOGY

OTOLOGIE

OTOLOGÍA

OTOLOGIA

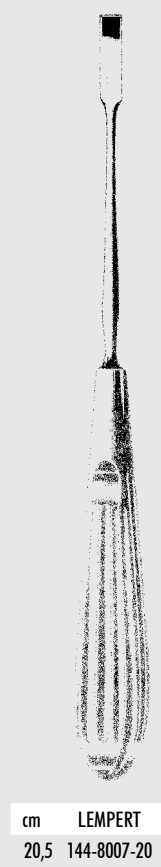

Raspatorium
Periosteal Elevator
Rugine-raspatoire
Elevador de periostio
Elevatore di periostio



Blutstillungsmeißel
Hemostat
Ciseau hémostatique
Cinzel hemostático
Scalpello emostatico



Periostmesser
Periosteal Knife
Couteau à périoste
Cuchillo de periostio
Coltello per periostio



OTOLOGIE

OTOLOGY

OTOLOGIE

OTOLOGÍA

OTOLOGIA

